

PLUS  
**PAPAYA**  
Dental X-ray Imaging system

- Panoramic
- Cephalometric
- Tomography



**NOAVARAN**  
DARMAN ATLAS  
[www.noavaran-da.com](http://www.noavaran-da.com)

# New Concept / Multi-function Imaging System, PAPAYA PLUS



Meet the convergence of new technologies to create a stable technology to meet the challenges and hopes for a new world.

Genoray strives to fulfill a commitment to meet the every changing challenges in the Dental imaging industry through advances in technology.

Always creating technology of tomorrow for you, Genoray

## Panoramic Imaging

- Papaya uses the CMOS sensor, which improves image quality while keeping radiation exposure to a minimum, Genoray has shown that it puts patient's safety first.

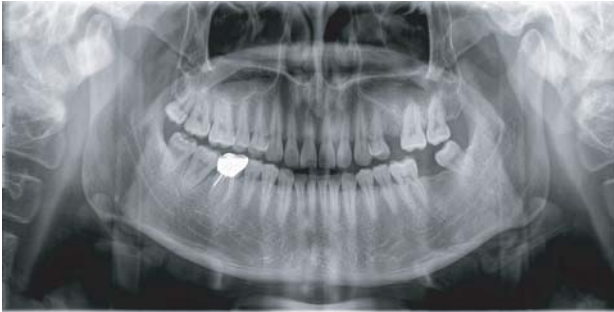

## Cephalometric Imaging

- When compared to the standard scanning method, PAPAYA PLUS has the shortest scan time.
- The short scan time reduces distortions caused by patient movement

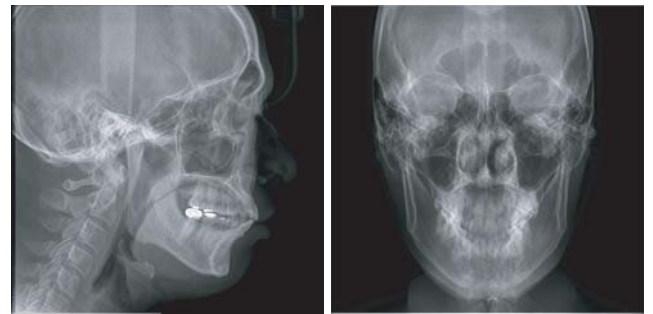

## Tomography Imaging (Optional)

PAPAYA can be upgraded without additional hardware to include the Tomography function.

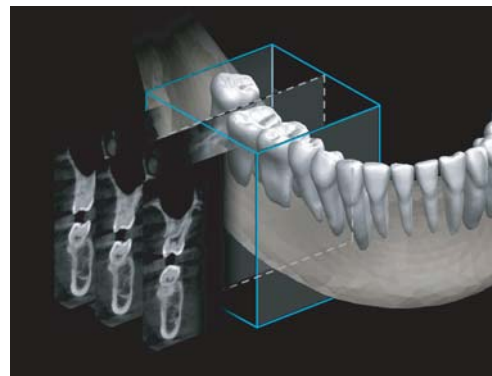

### Minimal investment, Maximal benefit

- PAPAAYA provides true 3D imaging on the panoramic system.
- High image quality due to statistical reconstruction technique.
- 3D image has 256 cross-sectional slices having 0.195mm thickness and has FOV 5x5x10.3cm.

# Panoramic

High Resolution Panoramic Image



- The Multi-focus function improves image analysis and avoids the need for re-exposure.
- The combination of linear and rotational movement allows for a greater variety of exposure modes

# Smart & compact design ! Digital X-ray imaging system,

Papaya: This smart design will allow for easy, fast setting and installation. Not only that, its compact design requires minimum space and is easily accessible for your patients.



Convenient accessory tray



User friendly LED indication



Comfortable hand grip

## User Friendly

PAPAYA increases user friendliness while maximizing efficiency



**Face to face positioning**



**Jaw Shape**

Fit each individual's jaw shape.



**Voice support system**

Machine's operation status is guided by voice support system



**Hand switch**

Machine and hand switch's LED display shows the current status of machine.



**Emergency switch**

In emergency, the machine can be stopped immediately with the emergency switch on the hand switch.



**Wheelchair accessible**

According to exposure mode, LED color changes.





## Multi-Focus Function

Multi-focus function is able to overcome operator's mistake from patient's faulty positioning and re-exposing X-ray. By reconstructing image with software way, the panoramic images layer can be corrected by multi-focus function.

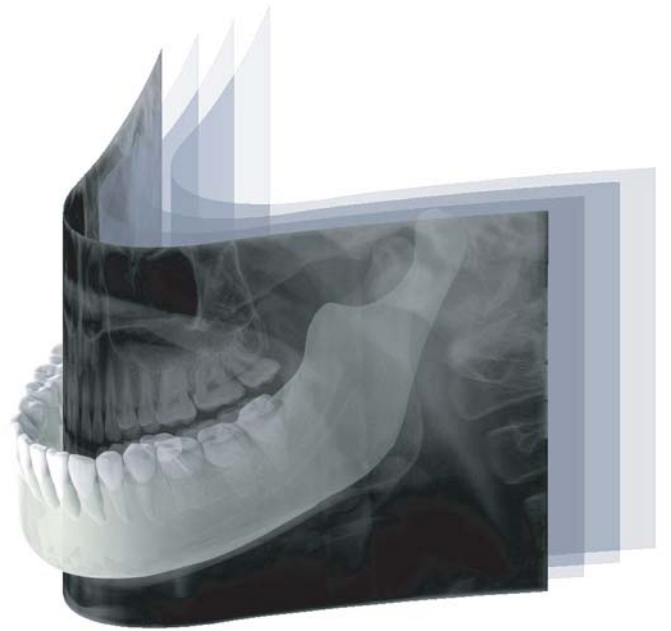

Only one scanning and acquired multiple image with maximum of 5 slices. It's slice interval can be varying 0.1 to 5mm.

## Various exposure options

- Multiple jaw shapes
- Selectable image quality (Fast, Normal, HD)
- Pre-set for easy exposure condition setting
- Horizontal & vertical X-ray segmentation for dose reduction
- TMJ detail setting for reducing patient dosage



## Exposure Programs

PAPAYA supports various kinds of exposure program, and they fulfill diagnosis needs.

Standard panoramic, orthogonal panoramic, bitewing panoramic, child panoramic, TMJ lateral double, horizontal & vertical X-ray segmentation, TMJ PA double, TMJ LAT-PA, TMJ LAT-PA double, sinus lateral and sinus PA are supported.



Standard panoramic

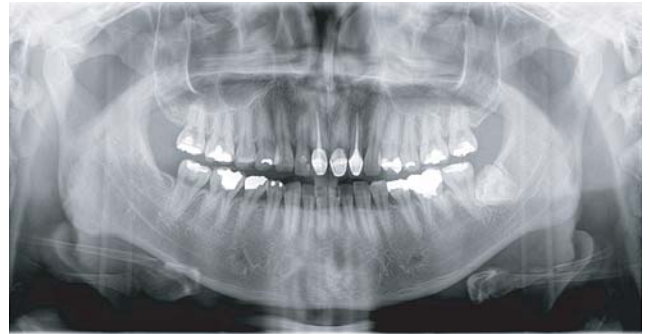

Orthogonal panoramic

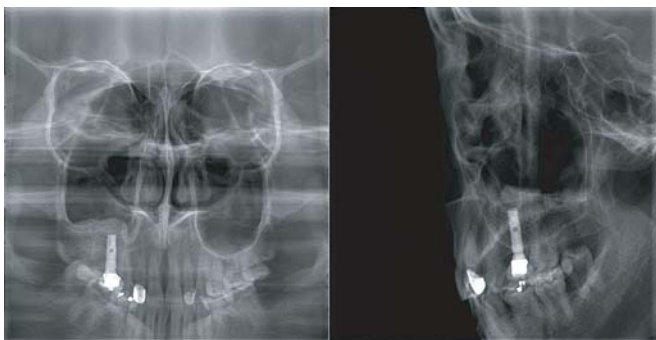

Sinus PA / Sinus lateral midsagittal



X-ray segment



Bitewing



TMJ lateral double

# Cephalometric

High Resolution Cephalometric Image



- The optimized mechanical structure designed for symmetrical balance that is made for enhanced safety and durability.
- The Cephalometric's FR laser makes it easy to position the patient.
- To avoid any operating mistakes, the position sensing sensor aids in the every exposure mode.
- It is enough only 4 second for scanning cephalo image on fast mode. This reduces motion artifacts.



## Exposure Programs

PAPAYA PLUS supports various kinds of exposure program, and they fulfill diagnosis needs.

Lateral, AP, PA, Water's view, Submento vertex, and carpus are supported.



Lateral



AP



Water's view



Submento vertex



Carpus

## Tomography Imaging (Optional)

Cubical Semi Tomography Technology

PAPAYA CUST is in a 3D imaging function that provides cross-sectional information for implant preparation.

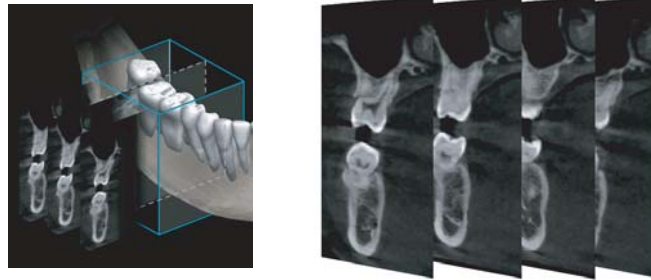

Dental Cross Sectional View

- Complements the panoramic image, and provides a tomographic image required for implant planning.
- When planning the implant, CUST images help the patient understand the procedure.
- PAPAYA with CUST function is economical compared to CBCT.



# TRIANA Genoray image viewer

TRIANA is able to manage all images from all devices; panoramic, cephalometric, intraoral, 3D X-ray as well as still camera imaging and intraoral video.

### Image viewing

Zoom, Panning, Comparing, Window Leveling

### Image enhancement, Printing

Paper, Film printer, WYSWYG

### Annotations

Line, Arrow, Text, Stamp

### Image import/export

bmp, jpg, gif, png, dcm, etc

### Measurement

Distance, Angle

### Measurement

Distance, Angle

### Implant Simulation, DICOM 3.0 compatibility

Storage (dicom send), film printer, worklist, etc



## PAPAYA operation software

PAPAYA exposure modes are prepared and initiated using clear step by step pictorial software.



Panoramic exposure mode



Cephalometric exposure mode



Patient positioning guide

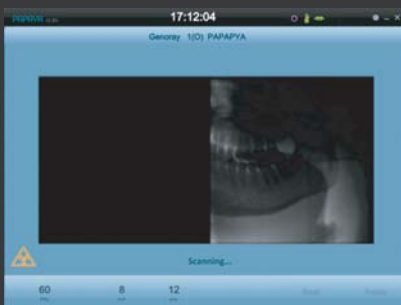

Realtime preview



Exposed image display



Status display

# Technical Specifications

## GENERAL

		PAPAYA	PAPAYA Plus
Panoramic Exposure		●	●
Cephalometric Exposure		—	●
Exposure Time	Panorama	9 ~ 17 sec	9 ~ 17 sec
	Cephalo	—	4 ~ 12 sec
Image Field Height (mm)	Panorama	150	152
	Cephalo	—	228
Focal Spot		0.5mm	
Target Angle		5°	
Maximum Tube Voltage		90kV	
Minimum Tube Voltage		60kV	
Anode Heat Storage Capacity		35kJ	
Maximum Anode Heat Dissipation Rate		250W	
Line Voltage		220 V, 50/60Hz	

## SENSOR

	PAPAYA	PAPAYA Plus
Pixel Pitch	75 x 75 μm	75 x 75 μm
Active Area	152 x 6.5 mm	228 x 6.5 mm

## CUST

X-ray beam	fan beam
Volumetric image size	50 x 50 x 103 mm
Number of slices	256
Slice thickness	0.195 mm

\* The specifications above can be changed to improve performance without notice.

## Dimensions

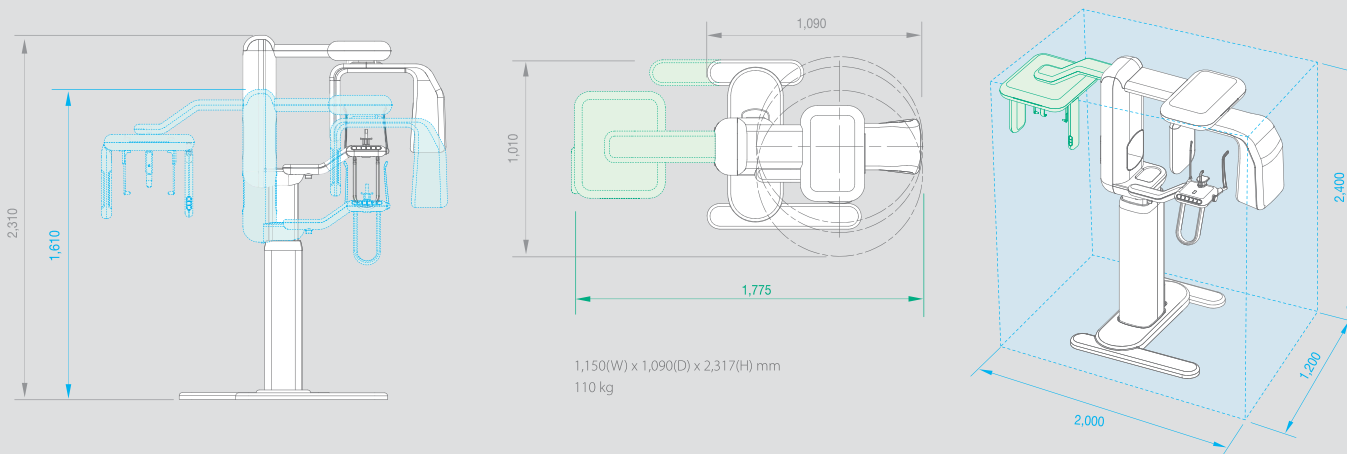

## Choose your own PAPAYA Serie

	PAPAYA	PAPAYA PLUS	PAPAYA 3D	PAPAYA 3D PLUS
Panoramic	●	●	●	●
3D Imaging			●	●
CUST Imaging	●	●		
Cephalometric		●		●



2460

**GENORAY Co.,Ltd.**  
512, 560, Dunchon-daero, Jungwon-gu,  
Seongnam-si, Gyeonggi-do, 13230, Korea  
Tel. +82-31-627-3900 Fax. +82-31-737-8016  
genoray@genoray.com www.genoray.com

**Genoray America Inc.**  
147 E. Bristol Lane Orange, CA 92865 USA  
Tel. +1-855-436-6729 Fax. +1-714-786-8919  
inquiry@genorayamerica.com  
www.genorayamerica.com

**Genoray EU GmbH**  
Westhafenstr. 1 13353 Berlin, Germany  
Tel. +49-30-509-694-98 Fax. +49-30-530-198-08  
smhan@genoray.com

**Genoray Japan**  
2F Ishibashi-Bldg, 1-4-15 Shinyokohama,  
Kouhoku-ku, Yokohama-city, Kanagawa, 222-0033 Japan  
Tel. +81-45-620-4971 Fax. +81-45-620-4972  
Info@genorayjapan.co.jp www.genorayjapan.co.jp